

# DEVELOPMENT OF MECHANICAL PROPERTIES OF SELF COMPACTING CONCRETE CONTAIN RICE HUSK ASH

R.Birundha Devi<sup>1</sup>, D.Seetha<sup>2</sup>, C.Ravi<sup>3</sup>

<sup>1</sup>PG Scholar, <sup>2,3</sup>Assistant Professor,  
Department of Structural Engineering,  
Oxford Engineering College, Trichy-620 009.

**Abstract:** The scope of this research is to determine the usefulness of Rice husk ash (RHA) in the development of economical self compacting concrete (SCC). The cost of materials will be decreased by reducing the cement content by using waste material like rice husk ash instead paper presents a study on the development of Mechanical properties up to 28 days of self-compacting and ordinary concretes with rice-husk ash (RHA), from a rice paddy milling industry (Manachanallur). The different replacement percentages of cement by RHA, 0%, 30%, 40% and 50%, water/cementitious ratios from 0.35 ordinary concrete and water /powder ratio from 1 self-compacting concrete were used to make concrete specimens. The 7day14 days and 28days results are compared with those of the self-compacting concrete with RHA replacement concrete, with compressive, split tensile, flexural strength and elasticity modulus.

**Index Terms:** Rice Husk Ash (RHA), Self Compacting Concrete (SCC), Compressive, Split Tensile, Flexural Strength.

## 1. INTRODUCTION

Self-compacting concrete (SCC), a new kind of high performance concrete (HPC) with excellent deformability and segregation resistance, was first developed in Japan in 1986. It is a special kind of concrete that can flow through and fill the gaps of reinforcement and corners of molds without any need for vibration and compaction during the placing process. The application of concrete without vibration in construction is not new. For examples, placement of seal concrete underwater is done by the use of a tremie without vibration, mass concrete has been placed without vibration. These seal, mass and shaft concretes are generally of lower strength, less than 34.5 MPa and difficult to attain consistent quality. Modern application of self-compacting concrete (SCC) is focused on high performance better and more reliability, dense and uniform surface texture, improved durability, high strength and faster construction.

The performance required for concrete structures is more complicated and diversified. The concrete is required to have properties like high fluidity, self compact ability, high strength, high durability, better serviceability and long service life of concrete structures. In order to address these requirements Self Compacting concrete (SCC) was developed. It is relatively new product that sees the addition of Super Plasticizers (SP) and Viscosity modifying admixture (VMA) to the concrete mix to significantly increase the ease and rate of flow. By its very nature, SCC does not require vibration. It achieves compaction into every part of the mould or formwork simply by means of its own weight without any segregation of the coarse aggregate.

### 1.1 SELF-COMPACTING CONCRETE

Self-compacting concrete (SCC) is defined as the concrete which can be placed and compacted into every corner of formwork, purely by means of its self-weight, by eliminating the need of either external energy input from vibrators or any type of compacting effort. The intention behind developing this concrete was the concerns regarding the homogeneity and compaction of cast-in-place concrete with in intricate, of paste (i.e. highly reinforced structures and improvement of overall durability, quality of concrete due to lack of skilled labors. This concrete is highly flow able and cohesive and enough to handle without segregation. It is also referred as Self leveling concrete, Super workable concrete, Self consolidating concrete, High flow able concrete and Non-vibrating concrete.

#### 1.1.1 WHAT IS RHEOLOGY?

Rheology is the study of the flow of matter, primarily in a liquid state, but also as 'soft solids' or solids under conditions in which they respond with plastic flow rather than deforming elastically in response to an applied force.

#### 1.1.2 RHEOLOGICAL PROPERTIES OF CONCRETE

The design of concrete with specified rheological properties for an application is not a new science, but it has taken on a new meaning with the wide use of self compacting concrete (SCC). In this industry, general terms such as “flow under its own weight”, and “filling capacity”, or workability, flowability, compactibility, stability, finishability, pumpability, and/or consistency are currently used interchangeably without a definition based on fundamental measurements of properties. Several attempts have been made to better relate fresh concrete properties with measurable quantities. Some researchers have treated fresh concrete as a fluid and used fluid rheology methods to describe concrete flow.

## 1.2 REQUIREMENTS OF SELF-COMPACTING CONCRETE

Increase of water-to-cementitious material increases the flow ability of cement paste at the cost of decrease in its viscosity and deformability the primary requirements of SCC. The SCC is flow able as well as deformable without segregation. Therefore in order to maintain deformability along with flow ability in paste, Super plasticizer is must in concrete. With Super plasticizers, the paste can be made more flow able with little decrease in viscosity. An optimum combination of W/C ratio and super plasticizers for achieving the self-compatibility can be derived for fixed aggregate content concrete.

## 1.3 ROLE OF MINERAL ADMIXTURES IN SELF-COMPACTING CONCRETE

High flow ability requirement of SCC allows the use of mineral admixtures in its manufacturing, use of mineral admixtures results in reduction in the cost of concrete. The incorporation of one or more mineral admixtures/powdery materials having different morphology and grain size distribution can improve particle-packing density and reduce inter-particle friction and viscosity. Hence it improves deformability, Self- compactibility and stability of SCC.

## 1.4 ROLE OF CHEMICAL ADMIXTURES IN SELF-COMPACTING CONCRETE

### 1.4.1 Super Plasticizers (SP) – Polycaroxylate Ester (Tec Mix 640)

Superplasticizers, also known as high range water reducers, are chemical admixtures used where well-dispersed particle suspension is required. These polymers are used as dispersants to avoid particle segregation (gravel, coarse and fine sands), and to improve the flow characteristics (rheology) of suspensions such as in concrete applications. Their addition to concrete or mortar allows the reduction of the water to cement ratio, not affecting the workability of the mixture, and enables the production of self-consolidating concrete and high performance concrete. Master Glenium SKY 8233 ensures that rheoplastic concrete remains workable in excess of 45 minutes at +25°C. Workability loss is dependent on temperature, and on the type of cement, the nature of aggregates, the method of transport and initial workability. To achieve longer workability period please use MasterSet RT 55. MasterGlenium SKY 8233 is a ready-to-use liquid which is dispensed into the concrete together with the mixing water. The plasticizing effect and water reduction are higher if the admixture is added to the damp concrete after 50 to 70% of the mixing water has been added. The addition of Master Glenium SKY 8233 to dry aggregate or cement is not recommended. Automatic dispensers are available.

### 1.4.2 Viscosity modifying admixture

A Self-compacting concrete should have high workability and viscosity. The fluidity of the mix increases as there is no internal friction between the particles and the concrete flows freely. Segregation occurs when the components of the concrete separates out into the mortar and large aggregates. Reaching a right balance between fluidity and resistance to segregation is essential for Self-compacting concrete. This balance is lacking when the fluidity of the concrete is obtained by adding water. Even through HRWA gives high fluidity, the required property of the Self-compacting concrete is not ensured. Therefore there is a need for Viscosity Modifying Admixture to attain required property.

The use of VMA in concrete mix has able to control viscosity and maintains internal cohesion of concrete during casting, as the polymer chains of the admixture arrange themselves in the direction of the flow of the mix.

## DEVELOPMENT OF SELF-COMPACTING CONCRETE

SCC MIX SHOULD MEET THESE KEY PROPERTIES:

- Ability to flow into and completely fill intricate and complex form under its own weight.
- Ability to pass through and bond to congested reinforcement under its own weight.
- High resistance to aggregate segregation.

The SCC mixes are designed and tested to meet the demands of the projects. For examples, the mix for mass concrete is designed for pumping and depositing at a fairly high rate. SCC was mixed at a batch plant at the job site and pumping through a piping system to the location of the anchorage 200m away. The SCC was dropped from a height of as much as 5m without aggregate segregation. For mass concrete, the maximum size for coarse aggregates may be as large as 50mm. The SCC construction reduced the construction time for the anchorage from 2.5 years to 2 years. Similarly SCC mixed can be designed and placed successfully for concrete members with normal and congested reinforcement. The coarse aggregate size for reinforced concrete generally varies from 10mm to 20mm.

## 1.6 APPLICATIONS OF SELF-COMPACTING CONCRETE

- SCC can be used in precast industries.
- In complicated reinforcement positions.
- Construction element in high rise buildings.
- Natural drought cooling tower tank bund areas.
- Marine structures.
- Reduced form work and equipment cost.
- Less man power.

The Aspect Ratio of a fibre is the ratio of its length to its 'equivalent' diameter. As long as a fibre's basic shape, tensile strength, dosage and anchorage mechanism remain the same, a higher aspect ratio will result in a steel fibre reinforced concrete element having a higher post-crack load carrying capacity. This improved performance is due to the increased fibre count i.e. there

are more fibres providing tensile capacity at each cracked section. The Aspect Ratio of the fibres chosen for a particular application is a function of economics and performance.

### 1.7 RICE HUSK ASH

The Rice husk ash is from Manachanallur rice paddy milling industry and treated by Grinding; its chemical composition is given in Table 1.1.

**Table 1.1 Chemical Composition Raw Material**

Materials	SiO <sub>2</sub>	Al <sub>2</sub> O <sub>3</sub>	Fe <sub>2</sub> O <sub>3</sub>	CaO	MgO	SO <sub>3</sub>	LOI
RHA	91.2	0.94	0.37	2.15	0.88	-	-
Cement	18.1	5.58	2.43	62	2.43	3.1	4.4

## 2. LITERATURE SURVEY

**B.H.V. PAI et al (2008). Comparative study of self compacting concrete mixes containing rice husk ash** investigated on SCC mixes containing Rise husk ash, and that containing rice husk ash as filler materials were tested for their fresh properties as per EFNARC guidelines. Both SCC mixes have satisfied all the acceptance criteria laid down by EFNARC. The hardened properties like compressive strength, split tensile strength and flexural strength were checked and found that not all the test results were satisfactory. Also, the optimum level of cement replacement with Rise husk ash ash for normal concrete is 35% The low strength of Rise husk ash based SCC is possibly due to the high amount of Rise husk ash (60.11% of total powder). It is also observed from the results that the calculated cement content (200kg/m<sup>3</sup>) as per the Nan Su et al. Method was not adequate to give the required strength to the mix. The quantity of cement content calculated was possibly not sufficient to bind all the ingredients in the mix.

**DR. INDRAJIT PATEL et al (2010). Effect of high volume Rise husk ash on rheological properties of self compacting concrete** investigated on in partial replacement of OPC with class F Rise husk ash does not affect the properties of fresh concrete to perform as Self Compacting Concrete. All the parameters for flowing, passing abilities are within limit specified in ENAARC standards. Use of Rise husk ash adds to the cohesiveness of mix, workability, reduction in bleeding and segregation and ultimately durability. Use of Rise husk ash addresses the issue of environmental and economic aspect and hence sustainability of concrete technology at large.

**DR C. D. MODHERA et al (2013). Process rise husk ash effect on harden properties of self compacting concrete**, investigated on SCC mixes are prepaid for different amount of Rise husk ash as a cement replacement, ranging from 30 to 70 percentages. During the study reduction in compressive strength observed as the Rise husk ash percentage got increase. It is observed that the split tensile strength of SCC got reduced as the flyash percentage increased.

**BSMA M. KASEM et al (2014). Mechanical properties of self-compacted fiber concrete** investigated on self compacting concrete the addition of either steel or polypropylene was noticed to enhance the fresh properties of self-compacted concrete by reducing the bleeding. While the control mix test specimens failed suddenly in flexure and impact, the counterpart specimens contain fibers failed in a ductile manner, and failure was accompanied by several cracks.

**K. M. A. HOSSAIN et al (2014). Characteristics of self-consolidating concrete incorporating volcanic ash** investigated on development of self-consolidating concrete (SCC) using volcanic ash (VA). Mix proportions, fresh and hardened properties as well as durability characteristics of twelve VA SCC mixtures demonstrate that VA can be used to develop SCC with acceptable properties. It is possible to produce SCC by using 20 to 50% VA as cement replacement. However, the replacement level of Portland cement by VA should be selected carefully in combination with water to binder ratio to achieve desired compressive strength, setting times and durability.

**SUMRERNGRUKZON et al (2014). Use of rice husk-bark ash in producing self compacting concrete** investigated on self compacting concrete containing fine irregular-shaped particles increases the amount of sp required. The use of the blend of pozzolans of fine ghrba also effectively improves the Scc in terms of corrosion and resistance to chloride penetration. The results indicate that the incorporation of 30% of Grhba decreases the corrosion, chloride penetration of self compacting concrete.

## 3. STUDY OF MATERIAL PROPERTIES

### 3.1 INTRODUCTION

Material testing is essential for the mix design of concrete. It gives the optimum amount of material required for a given strength and workability of concrete. Hence the properties of the following materials were found.

### 3.2 SPECIFIC GRAVITY

The specific gravity is the ratio of the density of a substance to the density (mass of the same unit volume) of a reference substance.

#### 3.2.1 Specific gravity of cement

The specific gravity bottle was weighed dry as  $W_1$  gram. The bottle was filled with distilled water and weighed as  $W_2$  gram. The specific gravity bottle was dried and filled with kerosene and weighed as  $W_3$  grams. Some of the kerosene was poured out and a weighed quantity of cement was introduced and weighed as  $W_4$  grams. 20 grams weight of cement was taken as  $W_5$  grams.

$$\text{Specific Gravity of Cement} = (W_2 - W_1) / (W_2 - W_1) - (W_3 - W_4) * 0.79$$

$$= (1125 - 622.5) / ((1125 - 622.5) - (1840 - 1518)) * 0.79$$

$$\text{Specific gravity of cement} = 3.14.$$

#### 3.2.2 Specific gravity of rice husk ash

The specific gravity bottle was weighed dry as  $W_1$  gram. The bottle was filled with distilled water and weighed as  $W_2$  gram. The specific gravity bottle was dried and filled with kerosene and weighed as  $W_3$  grams. Some of the kerosene was poured out and a weighed quantity of cement was introduced and weighed as  $W_4$  grams. 20 grams weight of cement was taken as  $W_5$  grams.

$$\text{Specific Gravity of RHA} = (W_2 - W_1) / (W_2 - W_1) - (W_3 - W_4) * 0.79$$

$$= (1155 - 622.5) / ((1155 - 622.5) - (1740 - 145.0)) * 0.79$$

$$\text{Specific gravity of RHA} = 3.00.$$

#### 3.2.3. Specific gravity of fine aggregate

The pycnometer was dried thoroughly and weighed as  $W_1$  gram. 200 gram of the sand was taken in the pycnometer and weighed as  $W_2$ . The pycnometer was filled with water up to the top. Then it was shaken well and stirred thoroughly with the glass rod to remove the entrapped air. After the air has been removed, the pycnometer was completely filled with water up to the mark. Then outside of the pycnometer was dried with a clean cloth and it was weighed as  $W_3$  grams. The pycnometer was cleaned thoroughly. The pycnometer was completely filled with water up to the top. Then outside of the pycnometer was dried with a clean cloth and it was weighed as  $W_4$  grams

$$\text{Specific Gravity of fine aggregate} = (W_2 - W_1) / (W_2 - W_1) - (W_3 - W_4)$$

$$= (1122.5 - 622.5) / ((1122.5 - 622.5) - (1831 - 1519))$$

$$\text{Specific Gravity of fine aggregate} = 2.659.$$

#### 3.2.4. Specific gravity of coarse aggregate

The container was dried thoroughly and weighed as  $W_1$  grams. 500g of the coarse aggregate were taken and were weighed again with container as  $W_2$  grams. Then sufficient water was added to cover the coarse aggregate half full and was screwed on the top. It was shaken well and stirred thoroughly with the glass rod to remove the entrapped air. After the air has been removed, container was completely filled with water up to mark. The outside of the container was dried with a cloth and was weighed as  $W_3$  grams. The container was cleaned thoroughly. The container was completely filled with water up to the top. The outside of the container was dried with a clean cloth and was weighed  $W_4$  g.

$$\text{Specific Gravity of fine aggregate} = (W_2 - W_1) / (W_2 - W_1) - (W_3 - W_4)$$

$$= (1125 - 622.5) / ((1125 - 622.5) - (1840 - 1518))$$

$$\text{Specific Gravity of fine aggregate} = 2.7.$$

### 3.3 BULK DENSITY

The bulk density of aggregates is the mass of aggregates required to fill the container of a unit volume after aggregates are batched based on volume. It depends on the packing of aggregate, either loosely packed aggregates or well dense compacted aggregates.

$$\text{Bulk density of coarse aggregate} = 1652.3 \text{ Kg/m}^3$$

$$\text{Bulk density of fine aggregate} = 1709.47 \text{ Kg/m}^3$$

### 3.4. FINENESS MODULUS

Fineness Modulus is defined as an empirical factor obtained by adding the total percentages of a sample of the aggregate retained on each of a specified series of sieves and dividing the sum by 100.

#### 3.4.1. Fineness test of cement

Correctly 100 grams of cement was weighed and taken in a standard IS sieve no 90 $\mu$ . The lumps were broken down and the material was sieved continuously for 15 minutes using sieve shaker. The residue left on the sieve was weighed. Weight of sample taken = 100 gms

$$\text{Weight of material after sieving} = 4 \text{ gms}$$

$$\text{Percentage of fineness} = (\text{weight retained} / \text{weight taken}) \times 100$$

$$\text{Percentage of fineness} = (4 / 100) \times 100 = 4\%$$

#### 3.4.2 Sieve analysis of fine aggregate

The sample was brought to air-dried condition before weighing and sieving was achieved after drying at room temperature. The air-dry sample was weighed and sieved successively on the appropriate sieves starting with the largest size sieve.

$$\text{Weight of sample} = 1000\text{g}$$

$$\text{Fineness of modulus} = \text{Cumulative \% of material retained} / 100$$

$$= 515.38 / 100$$

$$\text{Fineness of modulus} = 5.15 \text{ (Zone II).}$$



### 3.4.3. Sieve analysis of coarse aggregate

The sample was brought to air-dried condition before weighing and sieving was achieved after drying at room temperature. The air-dry sample was weighed and sieved successively on the appropriate sieves starting with the largest size sieve.

Weight of sample	= 2000g
Fineness of modulus	= Cumulative % of material retained / 100
Fineness of modulus	= 3.5

## 4. MIX DESIGN OF SELF-COMPACTING CONCRETE

The mix design of self-compacting concrete is a trial and error method. Many references available for mix proportioning of SCC.

The steps involved are:

- Target Mean strength
- Net volume of concrete
- Generally coarse aggregate content should be between 50 per cent and 60 per cent.
- The optimal volume content of sand in the mortar varies between 40 – 50 % depending on paste properties.
- Selection of Water powder ratio and water content,
- Selection of percentage of cement replacement.
- Selection of dosage of Super plasticizer and Viscosity Modifying Agent.

### 4.1. MIX PROPORTIONING FOR M30 GRADE CONCRETE

#### Step 1: Target Mean Strength

$$\begin{aligned} \text{Target mean strength} &= f_{ck} + (t \times S) \\ &= 30 + (5 \times 1.65) \\ &= 38.25\text{MPa} \end{aligned}$$

#### Step 2: Net Volume of Concrete

$$\begin{aligned} \text{Let us take total volume of concrete} &= 1000 \text{ litres} \\ \text{Air content} &= 2\% = 20 \text{ litres} \\ \text{Net volume of concrete} &= 980 \text{ litres} \end{aligned}$$

#### Step 3: Calculation of Coarse aggregate content

As per EFNARC guidelines, Recommended Range of Coarse aggregate content. (of net volume of concrete) = 50-60%

$$\begin{aligned} \text{Let coarse aggregate by volume} &= 55\% \\ \text{Coarse aggregate content} &= 0.55 \times 980 \\ &= 539 \text{ litres} \end{aligned}$$

$$\begin{aligned} \text{Bulk density of coarse aggregate} &= 1.652 \text{ kg/liters} \\ \text{Mass of coarse aggregate} &= 539 \times 1.652 \\ &= 890.4 \text{ kg} \\ \text{Specific gravity of coarse aggregate.} &= 2.78 \\ \text{Absolute volume of coarse aggregate.} &= 890.4 / 2.78 \\ &= 320 \text{ litres} \end{aligned}$$

#### Step 4: Calculation of Fine aggregate content

As per EFNARC guidelines, Recommended Range of Fine aggregate content (Of net volume of concrete) = 40-50%

$$\begin{aligned} \text{Let Fine aggregate by volume} &= 45\% \\ \text{Volume of mortar} &= 980-320 \\ &= 660 \text{ litres} \\ \text{Volume of fine aggregate} &= 660 \times 0.45 \\ &= 297 \text{ litres} \\ \text{Volume of paste} &= 660 \times 0.55 \\ &= 363 \text{ litres} \\ \text{Specific gravity of fine aggregate} &= 2.65 \\ \text{Mass of fine aggregate} &= 297 \times 2.65 \\ &= 787 \text{ kg.} \end{aligned}$$

#### Step 5: Calculation of water content

As per EFNARC guidelines, Recommended Water powder (W/P) ratio is 0.80-1.10

$$\begin{aligned} \text{W/P} &= 1.0 \\ \text{Filling material density} &= 1.9 \text{ kg/liter} \end{aligned}$$

Water =  $(363 \times 1.0)/1.9 = 193.10$  litres

**Step 6: Calculation of powder content**

Let powder consist  
 Cement =  $1.0 \times (191.05/1.0) \times 3.14$   
 = 551.74 kg

**Step 7: Dosage of Super plasticizer (SP)**

Let SP = 1.5% of powder  
 =  $0.015 \times 551.74$   
 = 8.27 kg.

**Table 4.1 Replacement of Cement By Rise Husk ASH(W/C-0.35)**

% OF RHA REPLACEMENT	CEMENT	RHA	SP (KG)	WATER (Lit)
OC RATIO	1Cu.m	-	-	-
0%	551.74	0	-	193.1
30%	386.22	165.52	-	193.1
40%	331.04	220.70	-	193.1
50%	275.87	275.87	-	193.1
SCC RATIO	1Cu.m	-	1.5%	-
0%	551.74	0	8.27	193.1
30%	386.22	165.52	8.27	193.1
40%	331.04	220.70	8.27	193.1
50%	275.87	275.87	8.27	193.1

**5.FRESH CONCRETE TESTS**

**5.1 Workability Tests**

**Slump test:**

Slump test is commonly adopted for ordinary concrete work .this test is performed with the help with the help of a vessel of the shape of the frustum of a cone and open at both ends .the top and bottom diameters of vessel should be 10cm and 20cm respectively and diameter it should be 30cm in height

**KEY PROPERTIES OF SELF-COMPACTING CONCRETE**

- ❖ Ability to flow into and completely fill intricate and complex form under its own weight.
- ❖ Ability to pass through and bond to congested reinforcement under its own weight.
- ❖ High resistance to aggregate segregation.

**5.2.1 Filling ability**

The ability of passing or flowing in horizontal and vertical direction without keeping air entrapped inside the concrete or at the surface is called filling ability. This can be done by slump flow test. The expected value of flow is 650-800mm.

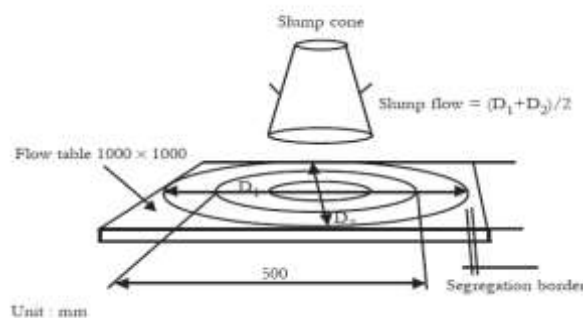

**Fig.5.1 Slump Flow Test**

### 5.2.2 Slump flow + T50

The slump flow test aims at investigating the filling ability of SCC. It measures two parameters: flow spread and flow time T50 (optional). The former indicates the free, unrestricted deformability and the latter indicates the rate of deformation within a defined flow distance.

**Table.5.1 Slump Flow Test**

S.no	Mix m30 RHA	Spreading dia		Efnarc recommended Result
		DIA	TIME (sec)	
1	0%	500	2.99	Spreading dia 500mm reach the concrete 2 to 5 secs .This test lower time indicates greater flowability
2	30%	500	3.28	
3	40%	500	3.76	
4	50%	500	4.05	

### 5.2.3 Passing ability

Passing ability is required to guarantee a homogenous distribution of the components of SCC in the vicinity of obstacles. The minimum bar distance to avoided blocking depends on the flow ability of SCC, on the maximum aggregates. This can be tested by L-Box.

**Table.5.2 Passing Ability Test**

S.NO	Mix- m30 RHA	Blocking ratio			Efnarc recommended Result
		H1 (mm)	H2 (mm)	H2/H1	
1	0%	150	132	0.88	The minimum acceptance value of 0.8-1.0 It measures the reached height of fresh SCC after passing through the specified gaps of steel bars
2	30%	150	129	0.86	
3	40%	150	123	0.82	
4	50%	150	120	0.80	

### 5.2.4 Segregation resistance

Segregation resistance is the resistance of the components of SCC to migration or separation. Particles having a relatively high density or a low surface volume ratio are more prone to segregation. This can be done by V-Funnel T5 minutes.

**Table.5.3 V-Funnel Test T5 Minutes**

S.NO	Mix m30 RHA	Flow of concrete		Efnarc recommended Result
		Time taken (operation) Minutes	Flowing Time (sec)	
1	0%	3.15	9	The V-funnel flow 5 minutes (8-12 sec allowed +3 sec) is the period a defined volume of SCC needs to pass a narrow opening and gives an indication the segregation resistance
2	10%	3.9	8	
3	15%	3.69	10	
4	20%	3.48	10	

## 6. HARDENED CONCRETE TEST

### 6.1 GENERAL

Experiments were conducted to determine the compressive strength, Flexural strength and water repellency property of concrete.

### 6.2 COMPRESSIVE STRENGTH:

Compressive strength is measured in UTM (Universal Testing Machine) i.e. maximum load at which the failure occurs is measured and the compressive strength is determined by the formula

Compressive strength=Load/ Area(N/mm<sup>2</sup>) or (psi)

**TABLE.6.1 7days,14 Days, 28 Days Ordinary Concrete Replacement of RHA Compressive Strength Comparision Results**

% of replacement	7 days (oc)	7 days (scc)	14 days (oc)	14 days (scc)	28 days (oc)	28 days (scc)
0%	21.11	22	28.81	33.48	37.4	40.00
30%	22.96	23.85	30.51	34.66	37.91	40.38
40%	20.23	21.85	25.34	28.29	36.29	37.77
50%	17.85	19.62	25.4	28.07	34.29	35.19

**Figure .6.1 7days,14 Days, 28 Days Ordinary Concrete Replacement of RHA Compressive Strength Comparision Results**

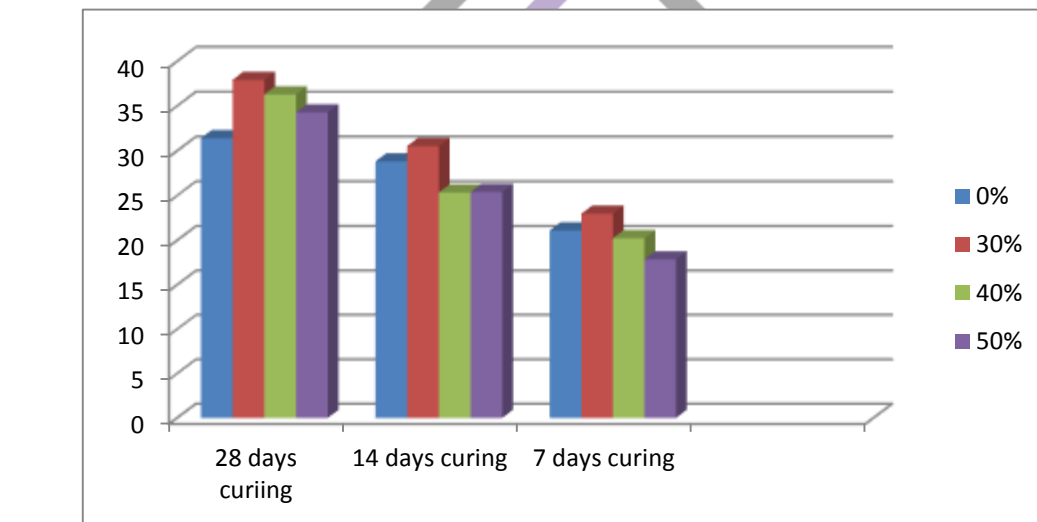

**Table 6.2 7days,14days, 28days Self Compacting Concrete Replacement of RHA Compressive Strength Comparision Results**

Sample designation	% of RHA	7 days compressive strength (n/mm <sup>2</sup> )	14 days compressive strength (n/mm <sup>2</sup> )	28 days compressive strength (n/mm <sup>2</sup> )
S0	0%	22.00	33.48	40.00
S1	30%	23.85	34.66	40.88
S2	40%	21.85	28.29	37.77
S3	50%	19.62	28.0	35.19



Figure 6.2 7days,14days, 28days Self Compacting Concrete Replacement of RHA Compressive Strength Comparision Results

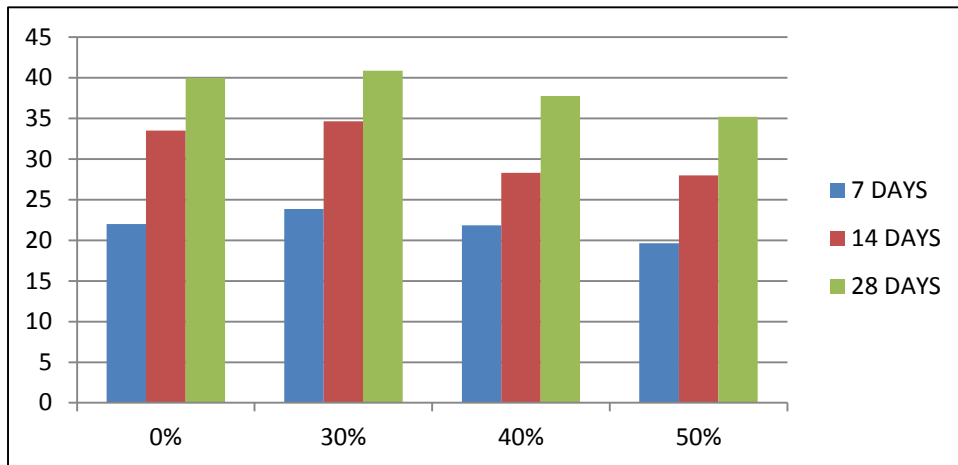

Figure 6.3 Compressive Strength Result Comparision of Ordinary Concrete & Self Compacting Concrete

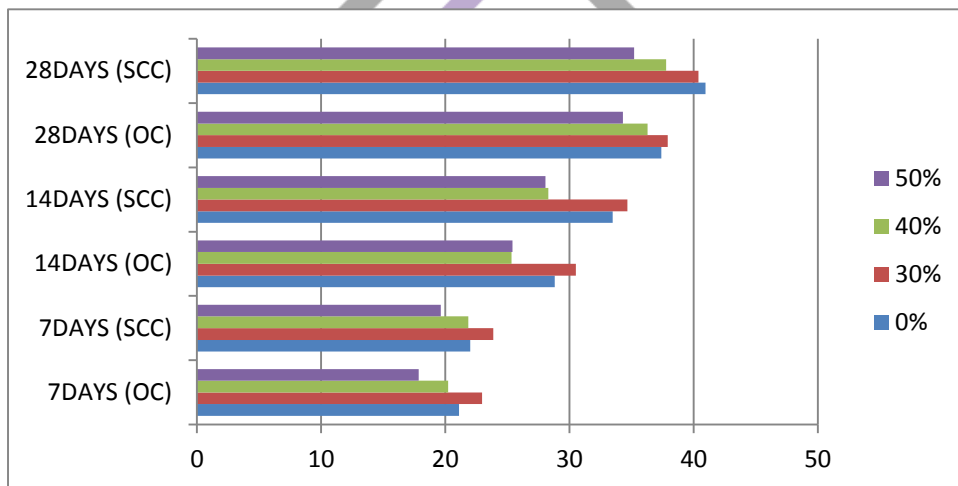

Table 6.3 7days,14days,28days comparison of OC and SCC for Short term Elastic Modulus

samples	% of replacement	7	14	28
		days	days	days
Oc	0%	22.97	26.83	28.01
Sec	30%	40.38	40.38	40.38
Sec	40%	23.45	28.93	31.62
Sec	50%	40.38	29.44	31.77

Figure 6.4 Comparison of OC and SCC for Short term Elastic Modulus

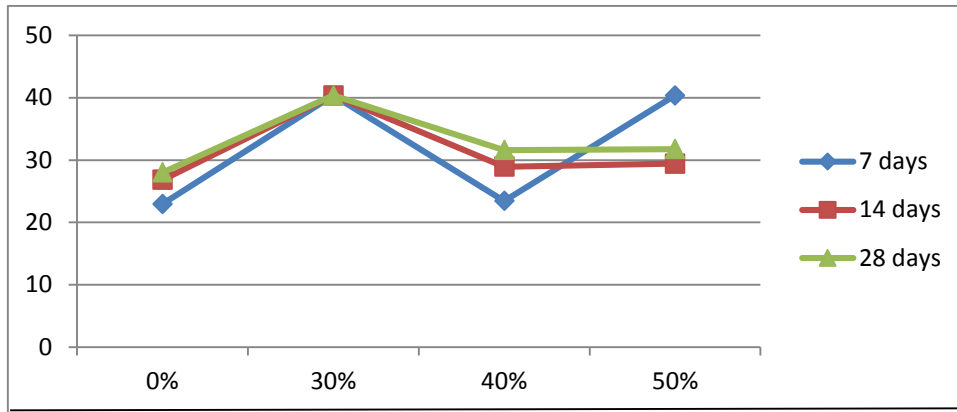
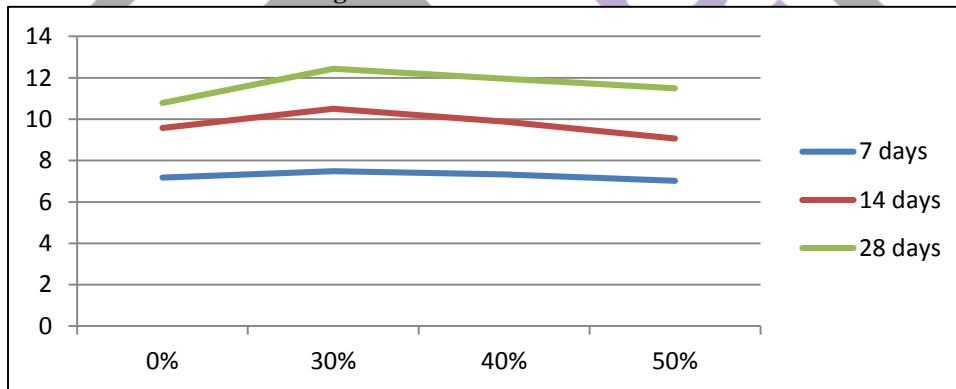

Table 6.4 7days, 14days, 28days Comparison of OC and SCC for Long term Elastic Modulus

Samples	% of replacement	7	14	28
		days	days	days
OC	0%	7.18	9.58	10.78
OC	30%	7.49	9.86	11.84
SCC	40%	7.33	10.33	12.16
SCC	50%	7.63	10.51	12.22

Figure 6.5 Comparison of OC and SCC for Long term Elastic Modulus



6.1.4 SPLIT TENSILE STRENGTH

The split tensile strength test has been conducted on beam specimen subjected loading and it has been observed that the strength of mixM30.Split tensile strength =  $2P/\pi ld$ .

TABLE 6.37days, 14 Days, 28 Days Ordinary Concrete Replacement of RHA Split Tensile Strength Comparison Results

Sample Designation	% OF RHA	7 Days Split Tensile Strength (N/MM <sup>2</sup> )	14 Days Split Tensile Strength (N/MM <sup>2</sup> )	28 Days Split Tensile Strength (N/MM <sup>2</sup> )
S0	0%	1.42	1.74	2.19
S1	30%	1.49	1.80	2.27
S2	40%	1.20	1.35	1.92
S3	50%	1.08	1.20	1.67

Figure 6.4 7days, 14 Days, 28 Days Ordinary Concrete Replacement of RHA Split Tensile Strength Comparision Results

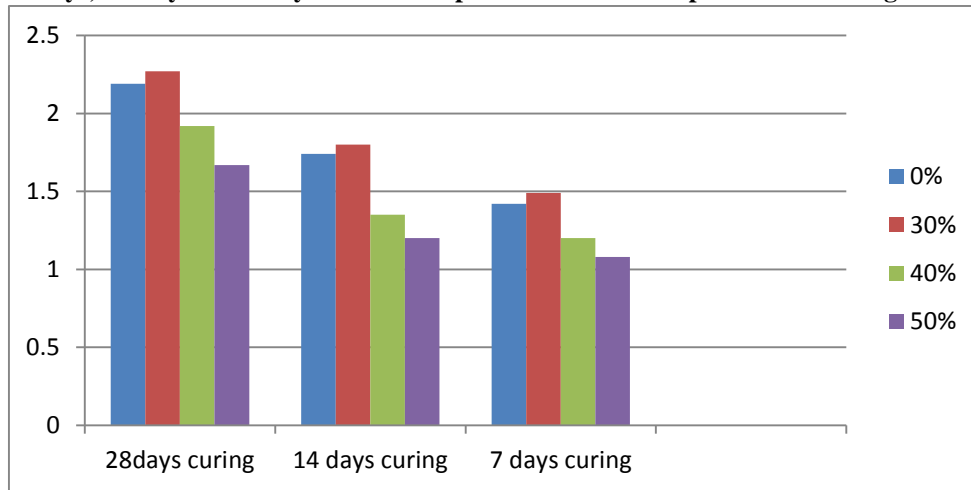

Table 6.4 7days, 14 Days, 28 Days Ordinary Concrete Replacement of RHA Split Tensile Strength Comparision Results

Sample designation	% of RHA	7 days split tensile strength (n/mm <sup>2</sup> )	14 days split tensile strength (n/mm <sup>2</sup> )	28 days split tensile strength (n/mm <sup>2</sup> )
S0	0%	1.52	2.05	2.30
S1	30%	1.47	2.07	2.33
S2	40%	1.31	1.47	2.02
S3	50%	1.18	1.45	1.87

Figure 6.5 7days, 14 Days, 28 Days Ordinary Concrete Replacement of RHA Split Tensile Strength Comparision Results

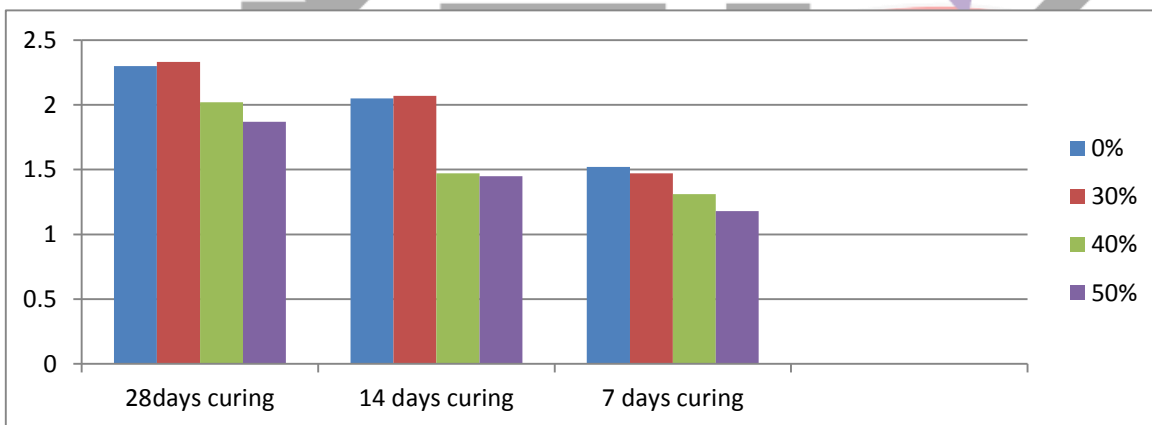
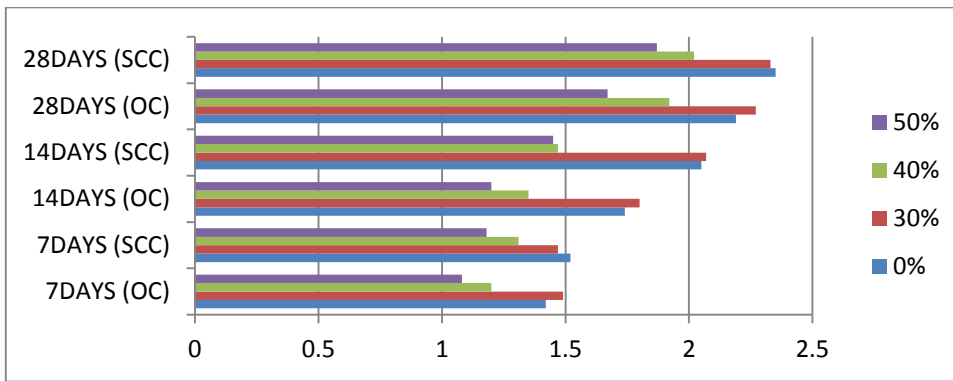

Figure 6.6 Split Tensile Strength Result Comparison of Ordinary Concrete & Self Compacting Concrete



6.1.5. FLEXURAL STRENGTH

The flexural strength test has been conducted on beam specimen (10x10x50) subjected to two points loading and it has been observed that the flexural strength of mixM30 .Flexural strength =  $pl/bd^2$ .

Table 6.5 7days,14 Days, 28 Days Ordinary Concrete Replacement of RHA Flexural Strength Comparison Results

Sample designation	% of RHA	7 days flexural Strength (n/mm <sup>2</sup> )	14 days flexural strength (n/mm <sup>2</sup> )	28 days flexural strength (n/mm <sup>2</sup> )
S0	0%	5.45	5.75	6.13
S1	30%	5.66	5.95	6.40
S2	40%	4.83	4.70	5.90
S3	50%	4.02	4.75	4.96

Figure 6.7 7days,14 Days, 28 Days Ordinary Concrete Replacement of RHA Flexural Strength Comparison Results

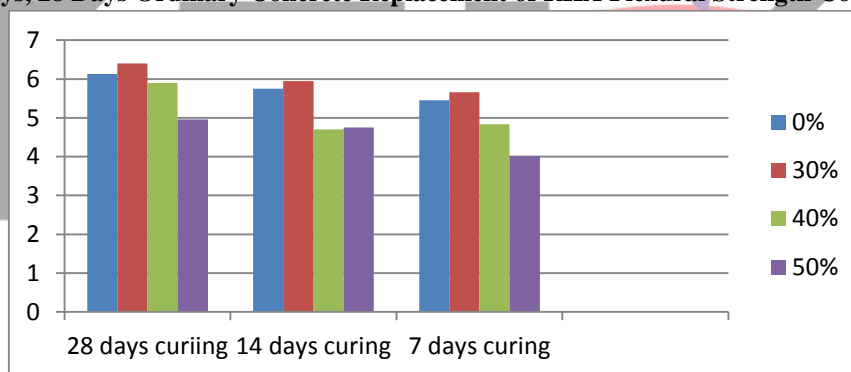
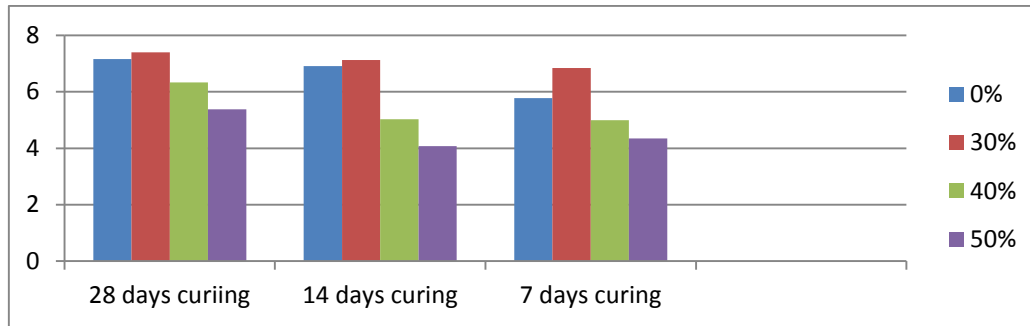
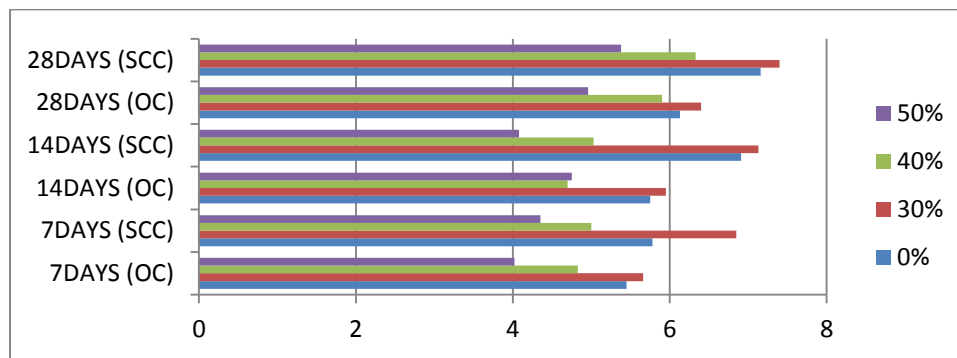

Table 6.6 7days,14 days, 28 days SCC replacement of RHA flexural strength comparison results

Sample designation	% of RHA	7 days flexural Strength (n/mm <sup>2</sup> )	14 days flexural strength (n/mm <sup>2</sup> )	28 days flexural strength (n/mm <sup>2</sup> )
S0	0%	5.78	6.91	7.16
S1	30%	6.85	7.13	7.40
S2	40%	5.00	5.03	6.33
S3	50%	4.35	4.08	5.38

**Figure 6.8 7 days, 14 days, 28 days SCC replacement of RHA flexural strength comparison results**

### 6.9 Flexural Strength Result Comparison of Ordinary Concrete & Self Compacting Concrete



#### 6.1.6 Determination of elastic modulus by using slope deflections method and initial tangent method

Maximum flexural stress =  $7.4 \text{ n/mm}^2$

Elasticity modulus in initial tangent method =  $5000\sqrt{f_{ck}} = 5000\sqrt{7.4} = 13.60 \times 10^3$

Elasticity in slope deflection method deflection =  $WL^3/48EI$

Maximum deflection =  $0.3342 \text{ mm}$

$I = BD^3/12 = 1004/12 = 8.33 \times 10^6$

$P = 14.8 \times 10^3 \text{ N}$

$B = 100 \text{ mm}$   $D = 100 \text{ mm}$   $L = 500 \text{ mm}$

Elasticity modulus  $E = WL^3/48 \times \text{deflection} \times I = 14.8 \times 10^3 \times 500^3/48 \times 8.33 \times 10^6 \times 0.3342 = 13.84 \times 10^3$

**Compare the result in initial tangent method and slope deflection near by same**

### CONCLUSION

In this project, it has been proposed a concrete preparation, by utilizing the Rice husk ash as a replacing cement in ordinary concrete and self compacting concrete. The major findings of the study are mechanical properties of concrete can be obtained with the replacement of cement with Rice husk ash from 0%, 30%, 40%, 50% percent. Better fresh properties of SCC can be obtained with the replacement of cement with rice husk ash from 30% compared with other replacement of rice husk ash. The strength of concrete is reduced for more than 40% replacements of rice husk ash. More than 30% replacement of cement by rice husk ash the fresh concrete will be segregated. The rice husk ash reduces the heat of hydration and reduce the shrinkage crack in self compacting concrete. The best hardened results give in self compacting as 30% replacement of rice husk ash in concrete. The bonding strength of rice husk ash is low compared with cement materials. The elasticity modulus varying with the age of concrete. It has proposed SCC give the maximum elasticity modulus at 28 days. During this study reduction in compressive strength observed as the above 30% Rice husk ash.

### REFERENCES

- [1] Tomasz ponikiewski and Jacek Golaszewski., 2013, "The high performance self compacting concrete modified by High Calcium fly ash".
- [2] Heba A. And Mohamed, 2011, "The effect of fly ash and silica fume on compressive strength of self-compacting concrete under different curing conditions"
- [3] Kishor S. Sable, and Madhuri K. Rathi., 2012, "Effect of different type of steel fibre and aspect ratio on mechanical properties of self compacted concrete".
- [4] ERHAN Guneyisi and Mehmet Gesoglu., 2015, "Fresh and rheological behavior of nano silica(NS) and fly ash(FA) blended self compacting concrete".



- [5] **Aleksandra Kostrzanowska-Siedlarz and Jacek Golaszewski**.,2015 “Rheological properties and the air content in fresh concrete for self compacting high performance concrete”.
- [6] **Rahmat Madandoust, Malek Mohammad Ranjbar and S.Fatemeh Shahabi**., 2015, “Assessment of factors influencing mechanical properties of steel fiber reinforced self-compacting concrete”.
- [7] **Rafat Siddique**, 2010, “The properties of self-compacting concrete containing class F fly ash”.
- [8] **Arnaud Castel, Thierry Vidal and Raoul François** studied 2010, “Experimental investigating the possible differences between bond and cracking properties of self-consolidating concrete (SCC) and vibrated concrete (VC)”.

